

Nellie's®

**WOW MOP**

**WOW MOPPE**



## 2 CONTENTS

- 3 ... Battery Replacement Program
- 4 ... WOW Mop Components
- 5 ... Carton Contents
- 6 ... Assembly
- 7 ... Instructions for Use
- 9 ... Operation Tips
- 10 .. Troubleshooting
- 12 .. Safety Instructions & Technical Parameters

EASY TO USE,  
POWERFUL AND  
ECO-FRIENDLY! YOU  
WILL LOVE YOUR NEW  
WOW MOP!



# BATTERY REPLACEMENT PROGRAM

## Base Battery Replacement

Batteries don't last forever. For the sake of our planet, check out our battery replacement program at [nellitesclean.com/our-planet](https://nellitesclean.com/our-planet).

### Notes:

- Do not try to replace the battery yourself.
- Overcharging the battery may cause damage.
- Please avoid charging for more than 3 hours.

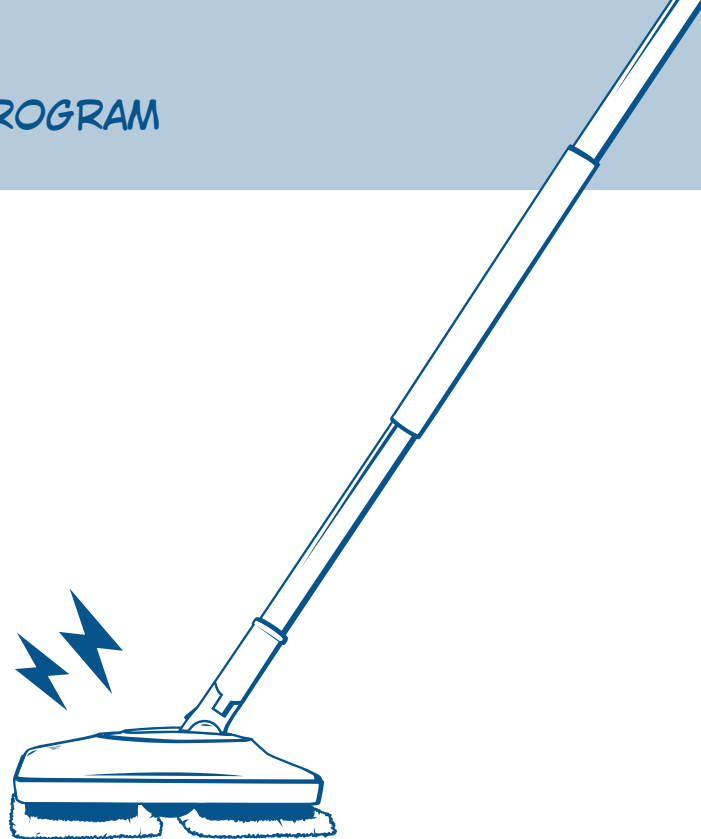

# 4 WOW MOP COMPONENTS

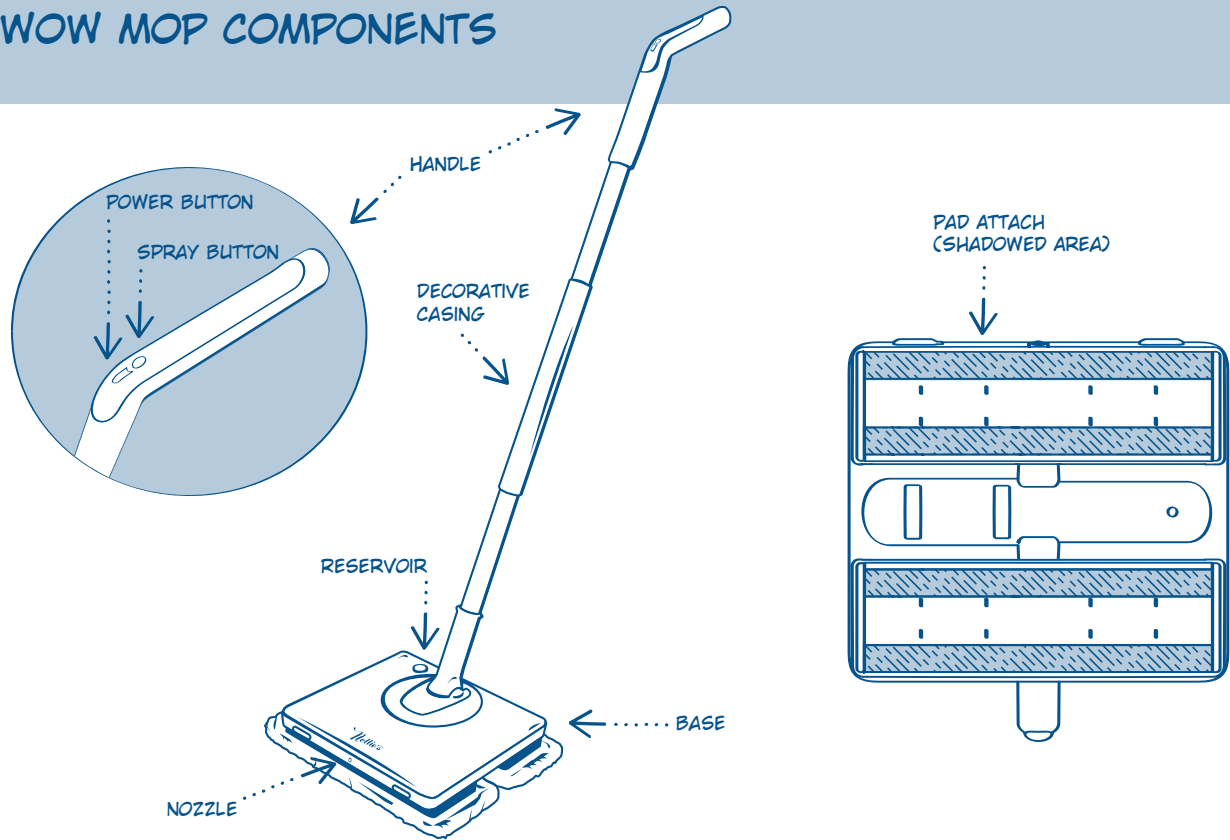

# CARTON CONTENTS

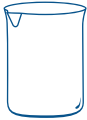

MEASURING CUP

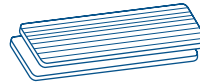

WOW WET FLOOR PADS

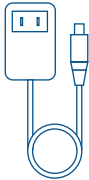

CHARGING CORD



USER MANUAL

## 6 ASSEMBLY

- 1** Press down the lock catch to make the aluminum pipe connect with the handle and decorative casing.

DECORATIVE CASING .....

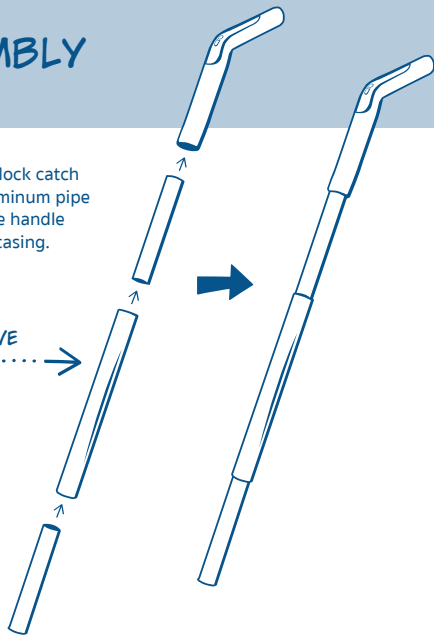

- 2** Press down the lock catch and insert the installed tube into the hole of the base.

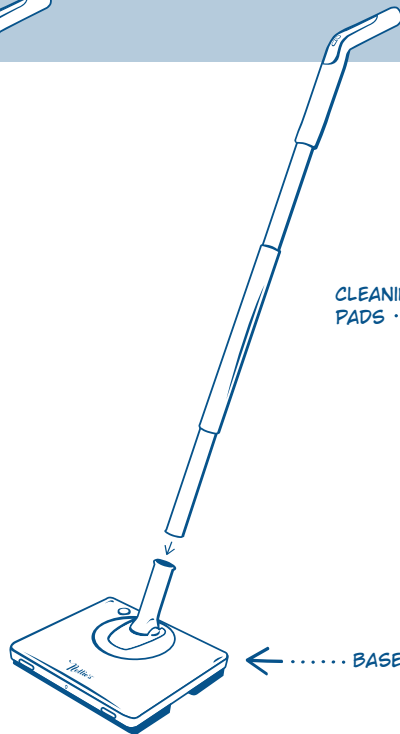

CLEANING PADS ...

- 3** Place the cleaning pads on the ground, lift the machine and place on the cleaning pads.

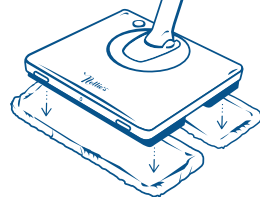

# INSTRUCTIONS FOR USE

## Power ON/OFF

Pull back the handle. After hearing a clicking sound, the headlamp and power indicator will light up. Bring handle to 90 degrees to turn off.

Note:  
The machine will automatically turn into "sleep mode" after 2 minutes of no use and the full battery light will twinkle.

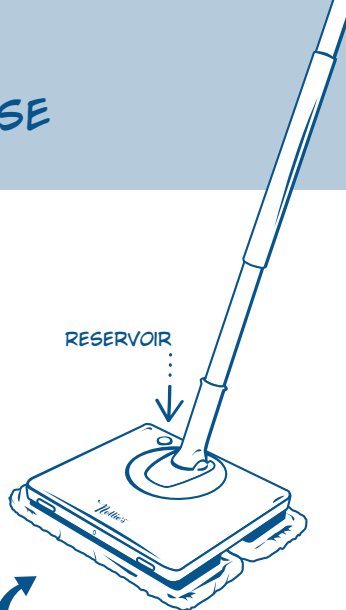
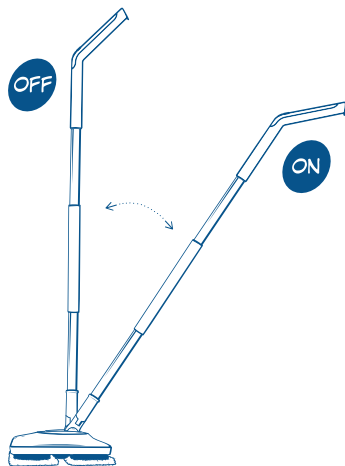

## Adding Cleaning Solution

Open the cap of the reservoir and fill using the measuring cup to add liquid. Do not overfill. Close the cap.

Best used with Nellie's Floor Care on hardwood, ceramic and tile.

Note:  
Maximum capacity of the reservoir is 230mL.

## Operating

Press the power button on the handle to make the cleaning pads oscillate, and press it again to stop.

While the pads are oscillating, hold down the spray button to spray cleaning solution. Release button to stop.

Notes:  
•Do not operate while the mop is charging.  
•The longest time of spraying is 5 seconds with one press.

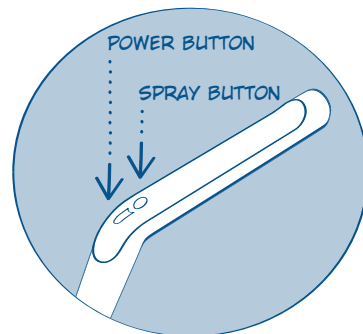

## Battery Lights

Three battery lights will show the status of the battery. 100%, 65% and 30%. 3 lights will flash when the machine is low in battery indicating to charge immediately.

### Notes:

• 3 lights on	100%
• 2 lights on	65%
• 1 light on	30%
• 3 lights flashing	low battery

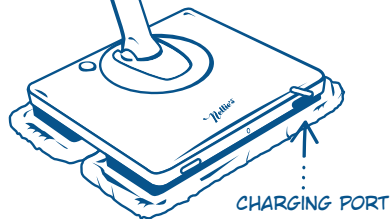
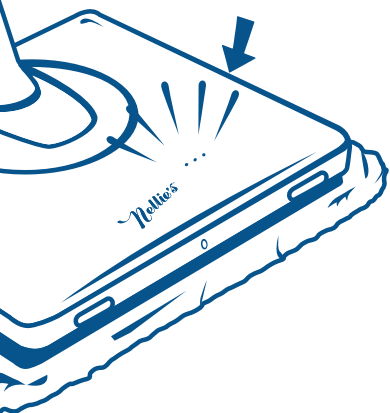

## First Time Charging

Pull out the rubber cork and turn it until the whole charging port is revealed. Plug the charger into the charging port.

### Note:

Use the original equipment manufactured adapter.

## Pad Changing

Unplug/turn off the machine. Ensure that the tank is empty. Hold the mop upside down and remove the pads from the bottom.

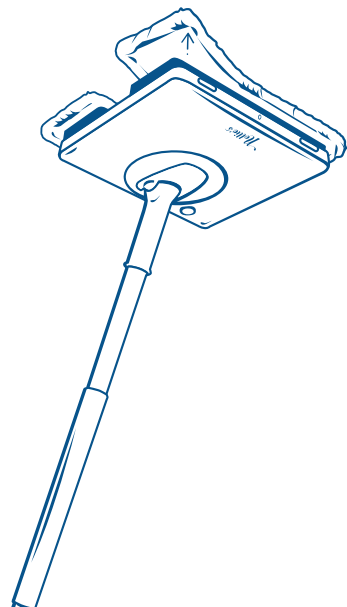



## Turning Off

Put handle in upright position to turn off.

## Cleaning Pads

Machine wash pads with fragrance-free detergent. Do not use fabric softener.

FYI Nellie's Laundry Soda works great!



## Replacing the Handle Battery

There are two screws located underneath the top of the handle. Remove the screws and the teal panel. Replace the battery.

The WOW Mop requires a 23A/12V battery.

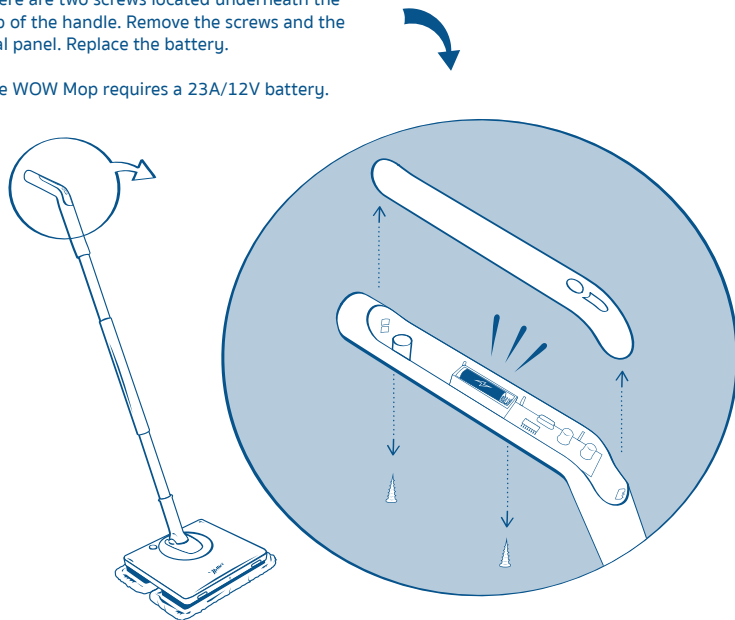

# 10 TROUBLESHOOTING

<b>Fault</b>	<b>Cause</b>	<b>Treatment</b>
Unit is wobbling.	<ol style="list-style-type: none"><li>1. Mop pads are not installed properly.</li></ol>	<ol style="list-style-type: none"><li>1. Turn power OFF and follow instructions on page 8 for replacing mop pads.</li></ol>
Reduced spray or no spray.	<ol style="list-style-type: none"><li>1. Reservoir may be empty.</li><li>2. System isn't completely primed.</li><li>3. Spray nozzle on base is clogged.</li></ol>	<ol style="list-style-type: none"><li>1. Refill reservoir.</li><li>2. Hold spray button for 10 to 15 seconds to make sure the solution has flowed to the spray nozzle.</li><li>3. Turn power OFF. Use a pin to clean the spray nozzle located at the front of the machine.</li></ol>
Power button does not turn on the machine.	<ol style="list-style-type: none"><li>1. Handle is standing upright.</li></ol>	<ol style="list-style-type: none"><li>1. Recline handle.</li></ol>

Fault	Cause	Treatment
No power.	<ol style="list-style-type: none"><li data-bbox="538 317 703 334">1. Battery depleted.</li><li data-bbox="538 387 762 405">2. Charging cord damaged.</li><li data-bbox="538 436 684 453">3. Battery failure.</li></ol>	<ol style="list-style-type: none"><li data-bbox="976 317 1348 358">1. Charge battery for approximately 3 hours. Avoid overcharging.</li><li data-bbox="976 387 1371 405">2. Do not use. Contact Nellie's customer service.</li><li data-bbox="976 436 1371 453">3. Do not use. Contact Nellie's customer service.</li></ol>
Machine is leaking.	<ol style="list-style-type: none"><li data-bbox="538 505 877 523">1. Cap of reservoir is not closed properly.</li></ol>	<ol style="list-style-type: none"><li data-bbox="976 505 1188 523">1. Close the cap properly.</li></ol>
Lights are on but unit won't start vibrating.	<ol style="list-style-type: none"><li data-bbox="538 574 869 592">1. The battery in the handle is depleted.</li></ol>	<ol style="list-style-type: none"><li data-bbox="976 574 1362 618">1. Follow instructions on page 9 to replace the battery in the handle.</li></ol>

# 12 SAFETY INSTRUCTIONS & TECHNICAL PARAMETERS

## Usage

For home use only.

Remove large particles or substances from the floor before using. This product is not for sweeping or vacuuming.

In case of jam caused by small objects, power off before removing the objects.

Do not let children use the mop as a toy.

Use a rag to clean the mop when it's powered off.

Do not leave any solution in the reservoir for more than 24 hours.

## Battery & Charging

Do not use charger and charging batteries provided by any third parties.

Do not self disassemble or remodel the battery and charger.

Keep the charger away from heating sources such as radiators.

Do not touch the charger with wet cloths or wet hand.

Please send the used batteries for recycling by certified organizations or learn more about our Battery Replacement Program at [www.nelliesclean.com/our-planet](http://www.nelliesclean.com/our-planet).

If there is any damage to the cable please stop using and contact Nellie's customer service.

Name	Parameters
Battery	2000 mAh
Voltage Rating	12 V
Rated Power	35 W
Power Charger Voltage	12.6 V
Charging Time	3 - 5 h
Run Time	55 min

